

2η Άσκηση (Branch Prediction)

Άσκηση 1η (1α)

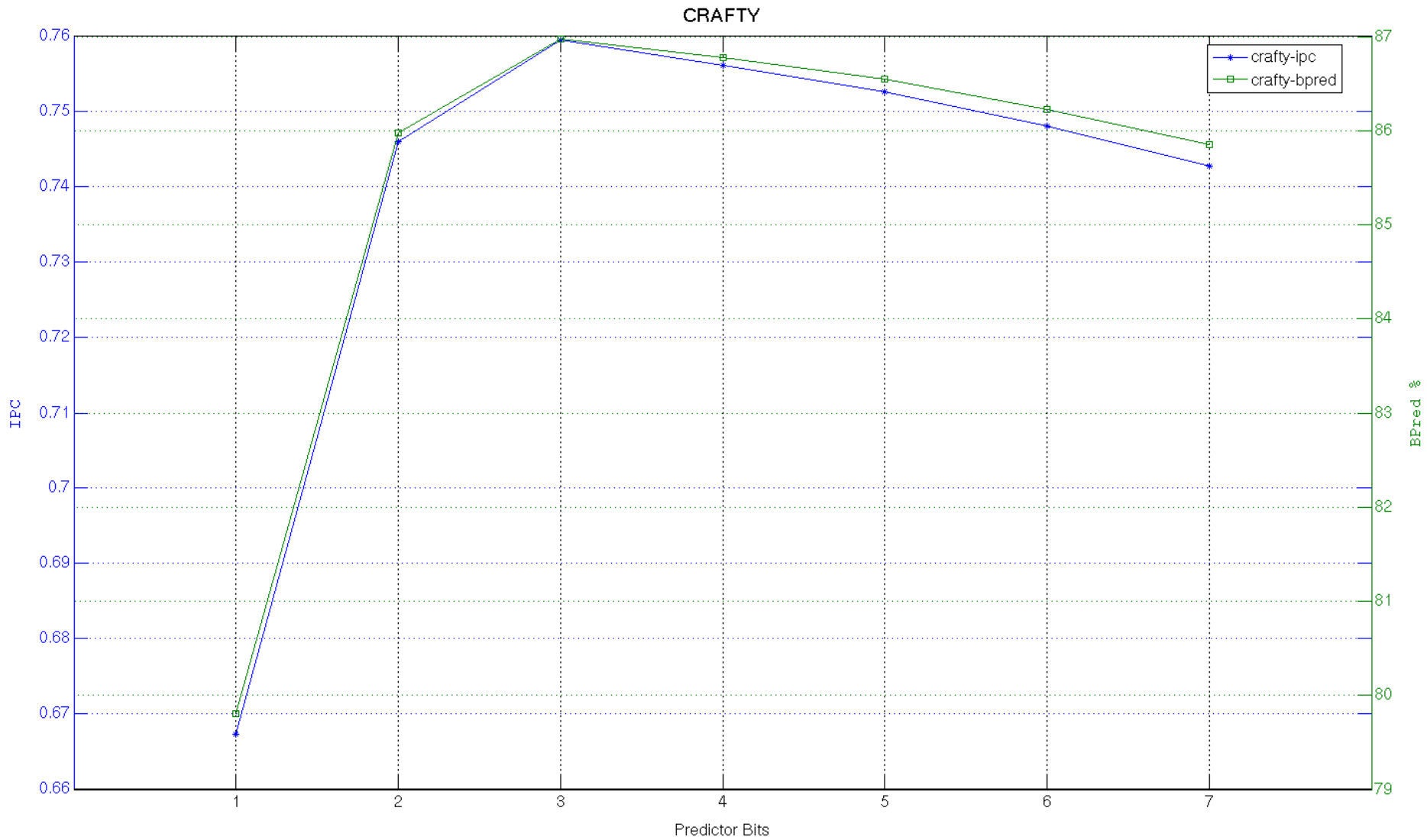

Άσκηση 1η (1a)

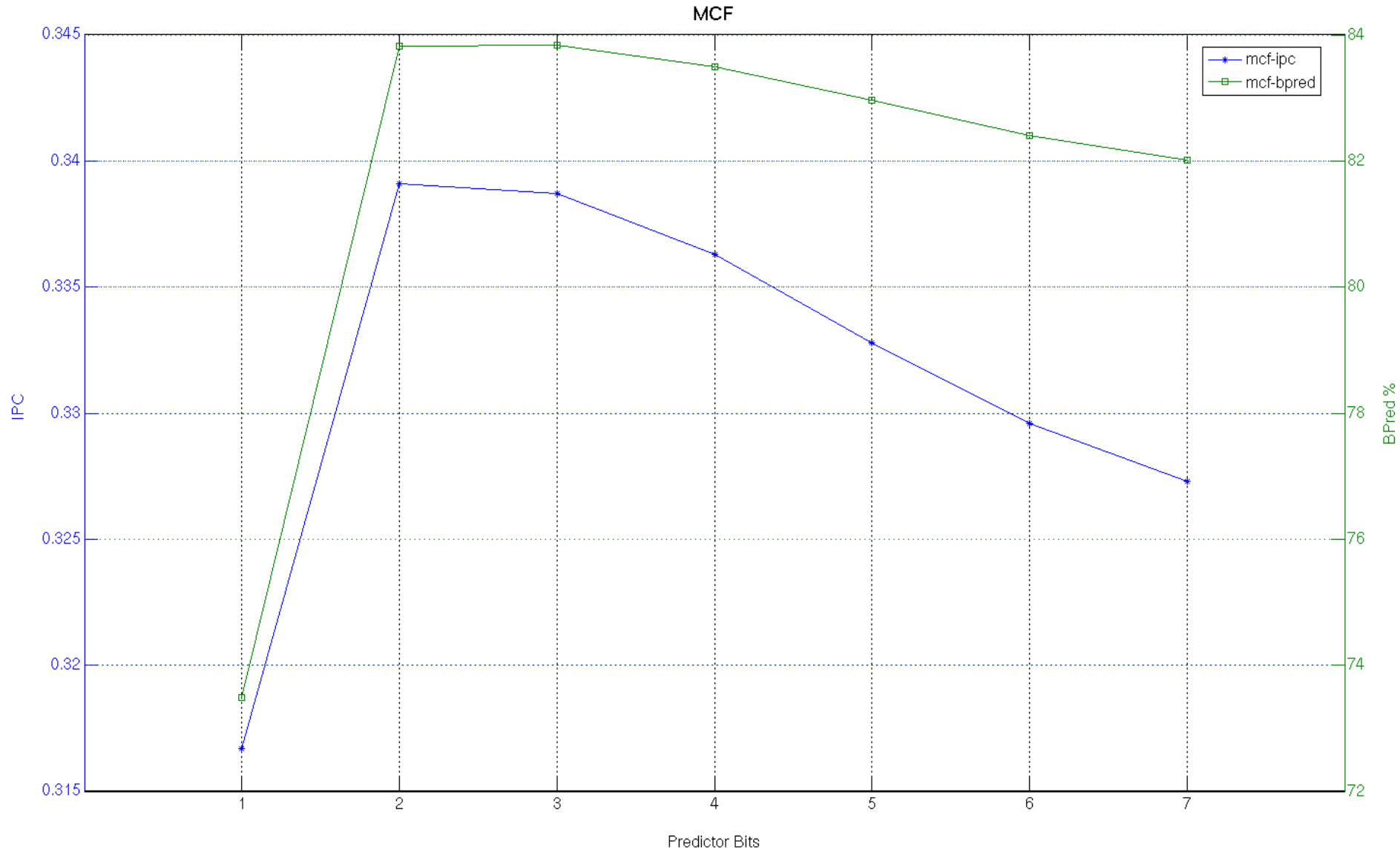

Άσκηση 1η (2a)

CRAFTY

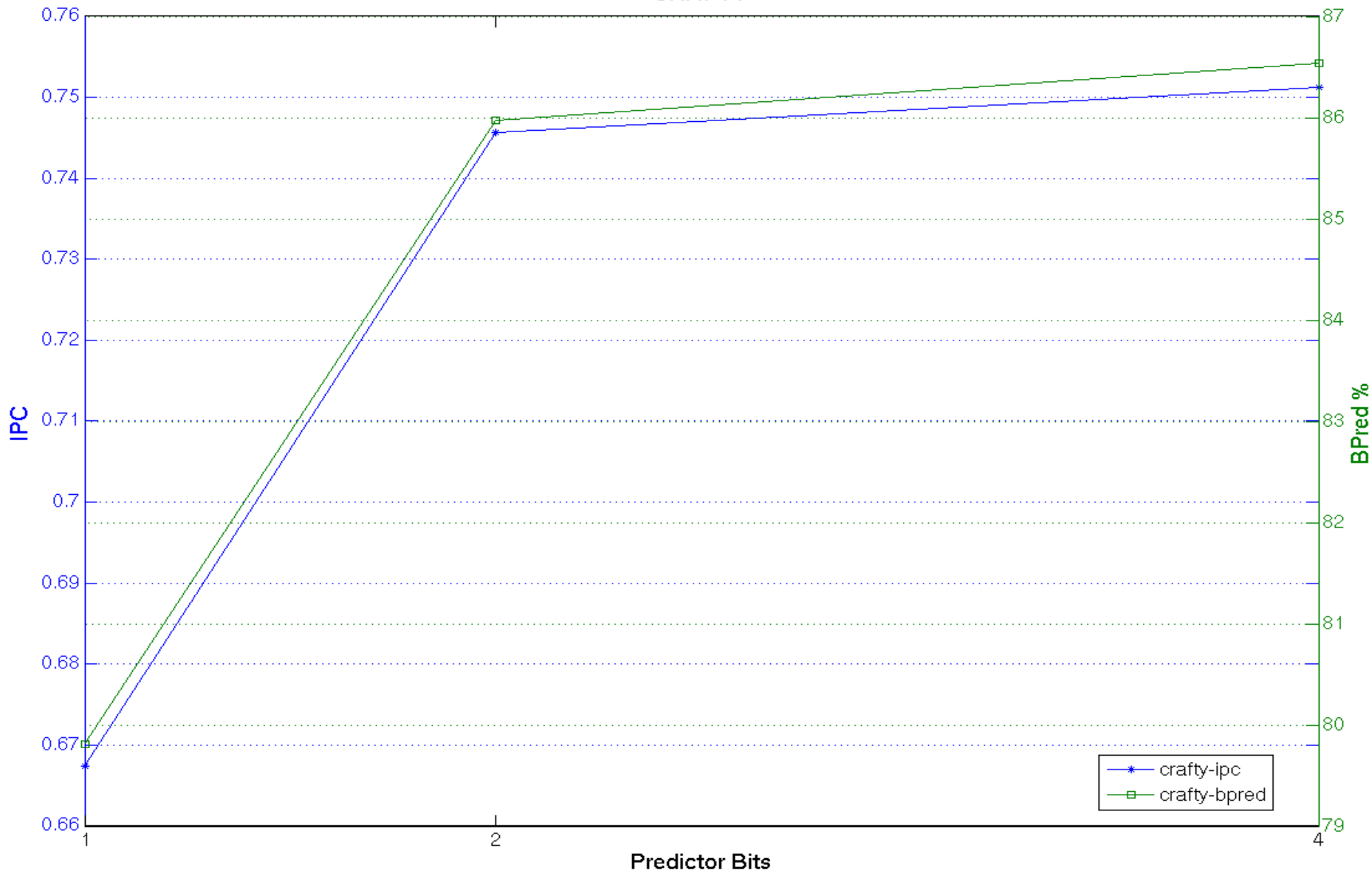

Άσκηση 1η (2α)

MCF

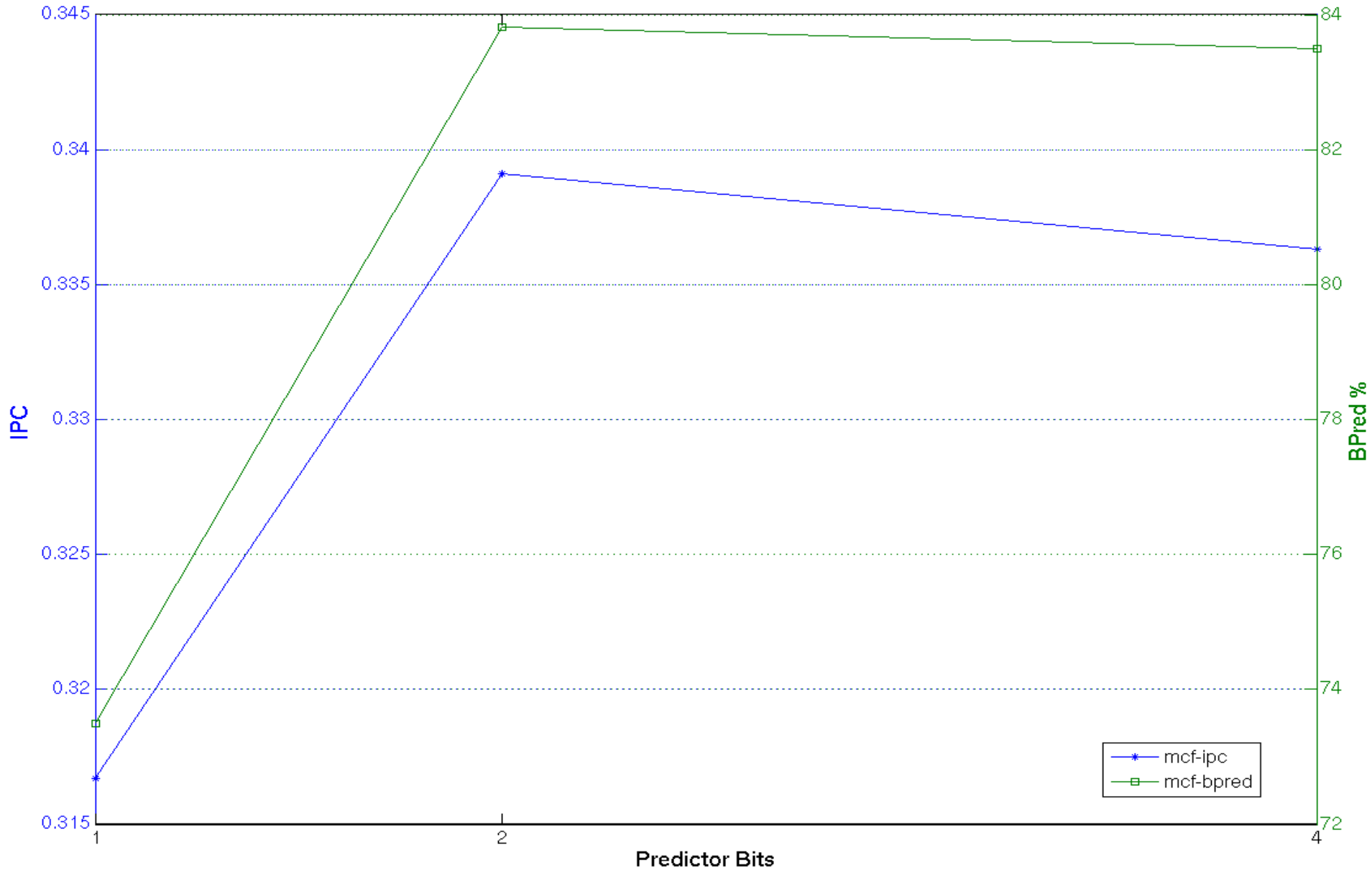

Άσκηση 1η (2α)

	CRAFTY			MCF		
bits	IPC	Tot	BPred	IPC	Tot	Bpred
1	0.6674	74.37	79.81	0.3167	65.64	73.49
2	0.7457	80.11	85.97	0.3391	74.87	83.82
4	0.7513	80.64	86.54	0.3363	74.59	83.50

- IPC
 - (4 → 2 bits) **-0.7%** για crafty και **+0.83%** για mcf
- Bpred
 - (2 → 4 bits) **+0.57** για crafty και **-0.32** για mcf
- IPCSum
 - (2 bits) **1.0848**
 - (4 bits) **1.0876**

Άσκηση 2η (RAS)

CRAFTY

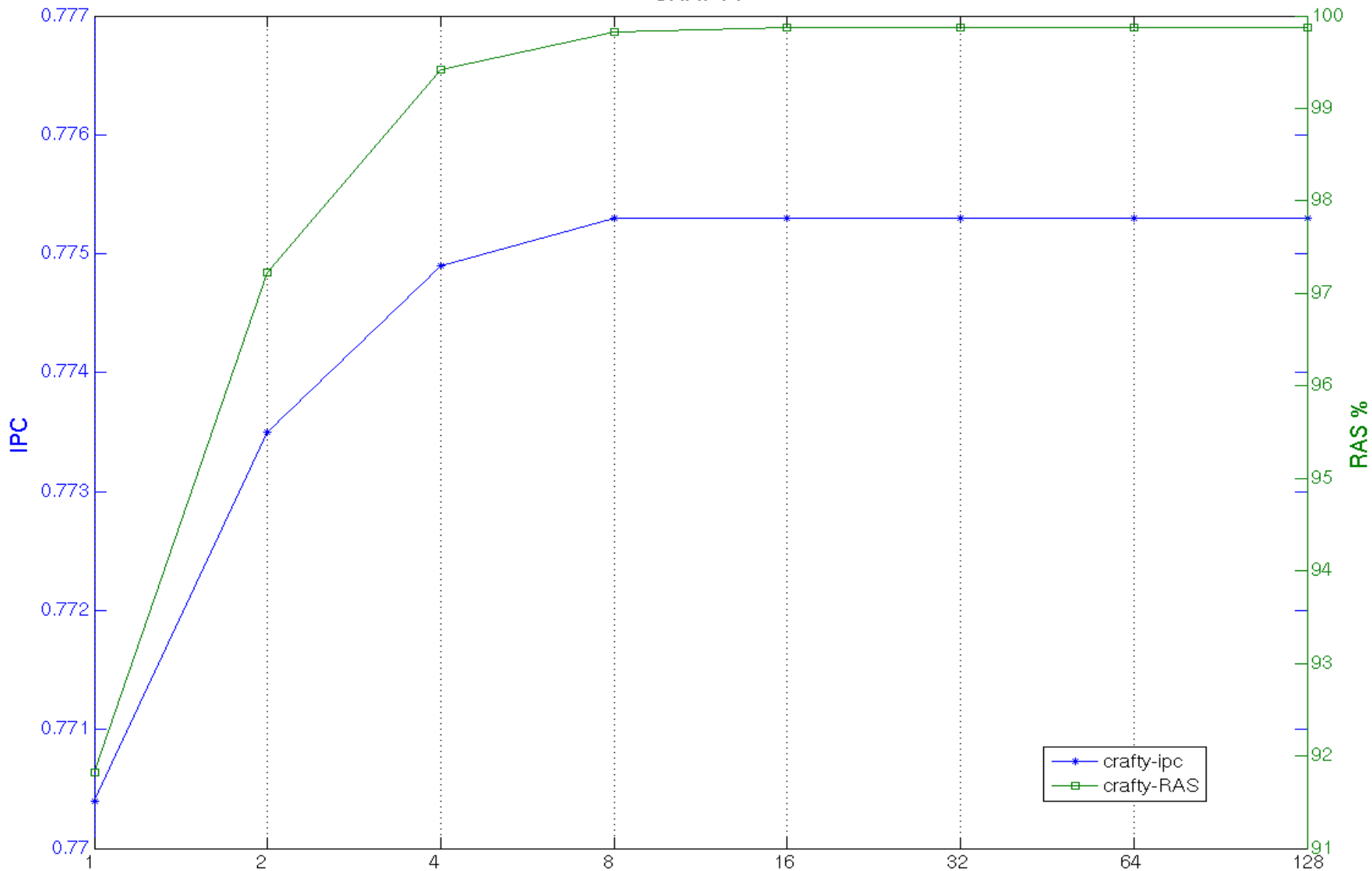

Άσκηση 2η (RAS)

MCF

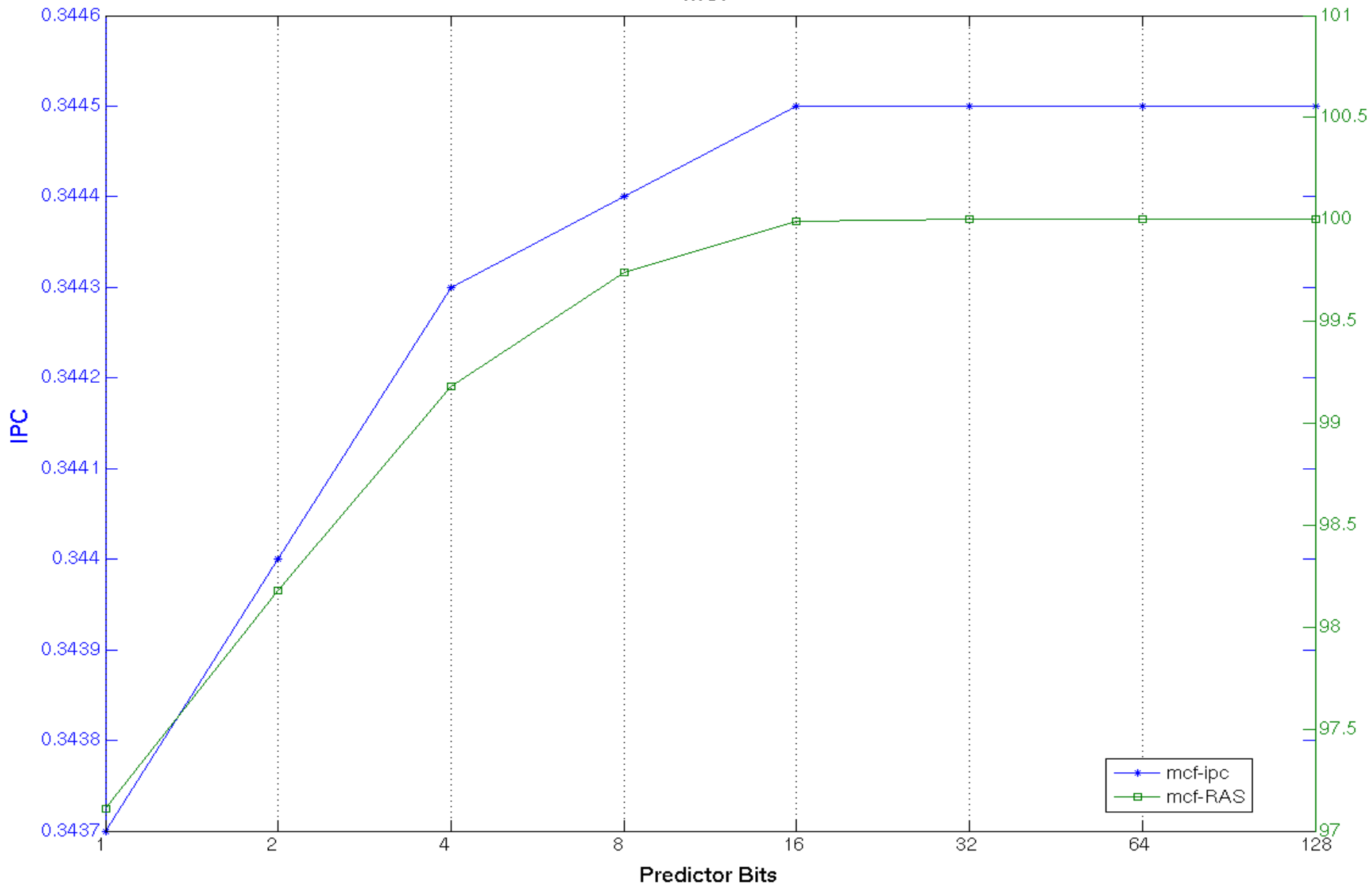

Άσκηση 3η (BTB)

CRAFTY

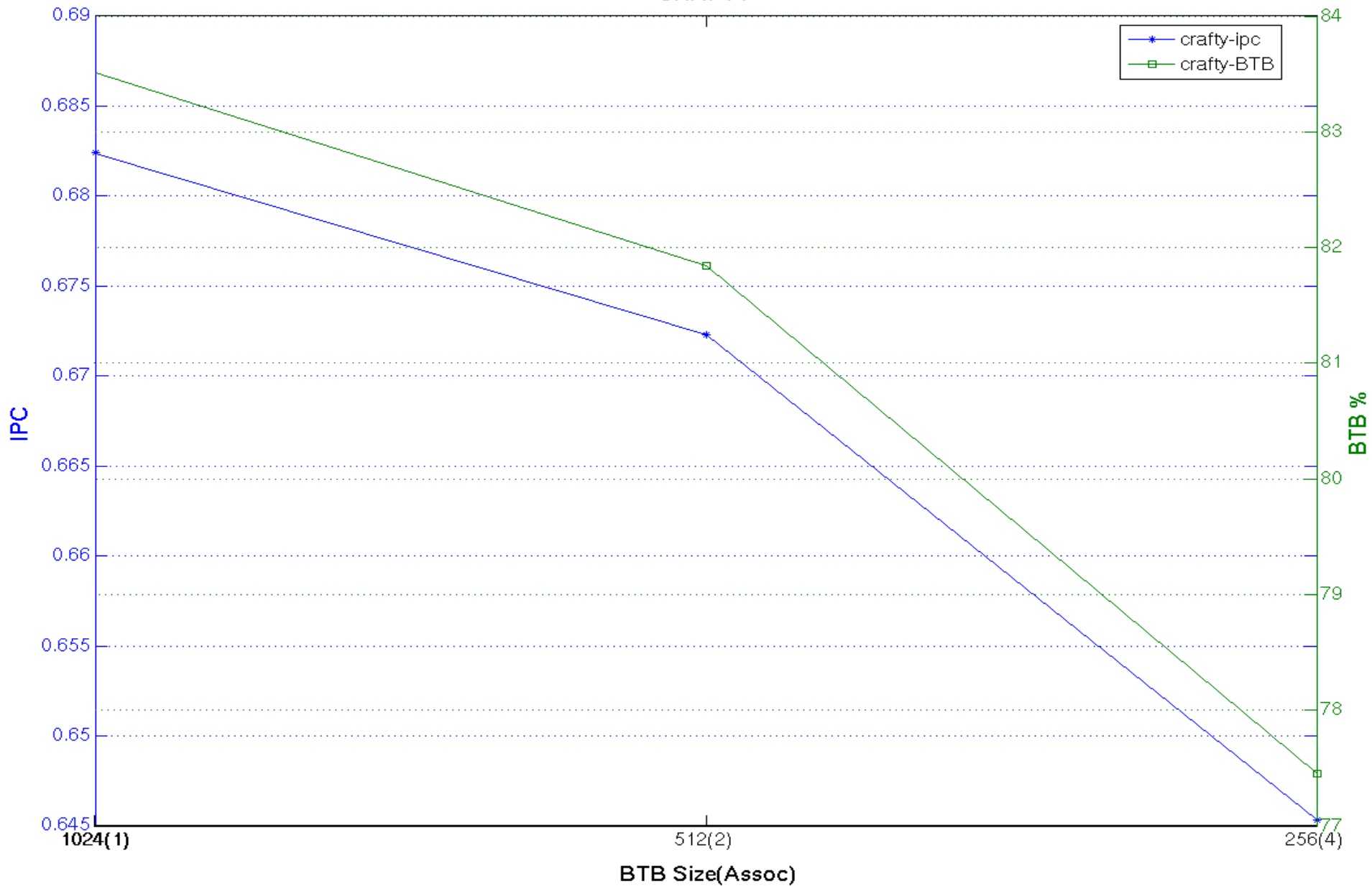

Άσκηση 3η (BTB)

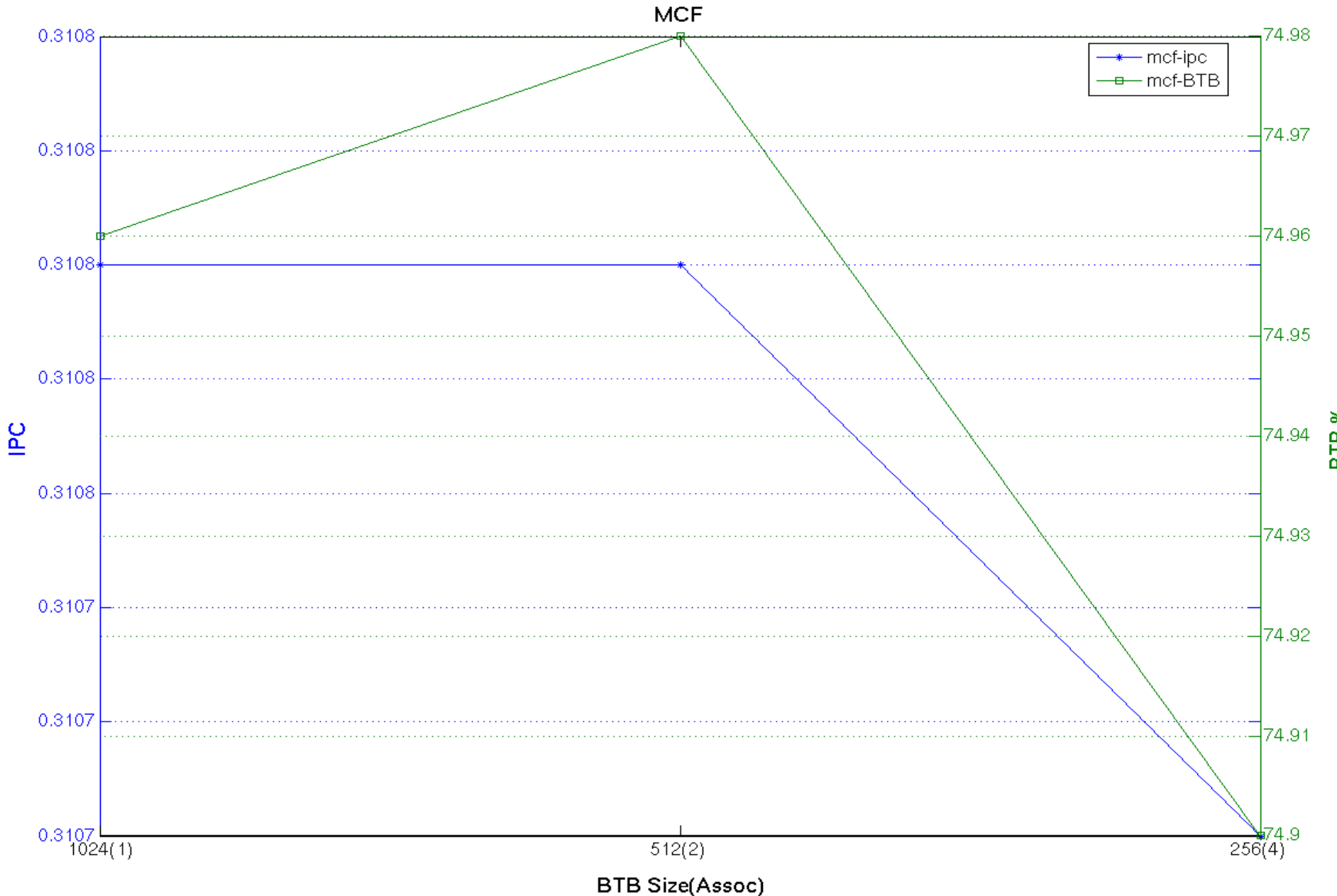

Local-History Two-Level Predictor

- BHT
 - 1024 ή 2048
 - z-bit ιστορία
- PHT
 - 1024 εγγραφές
 - 2-bit predictors

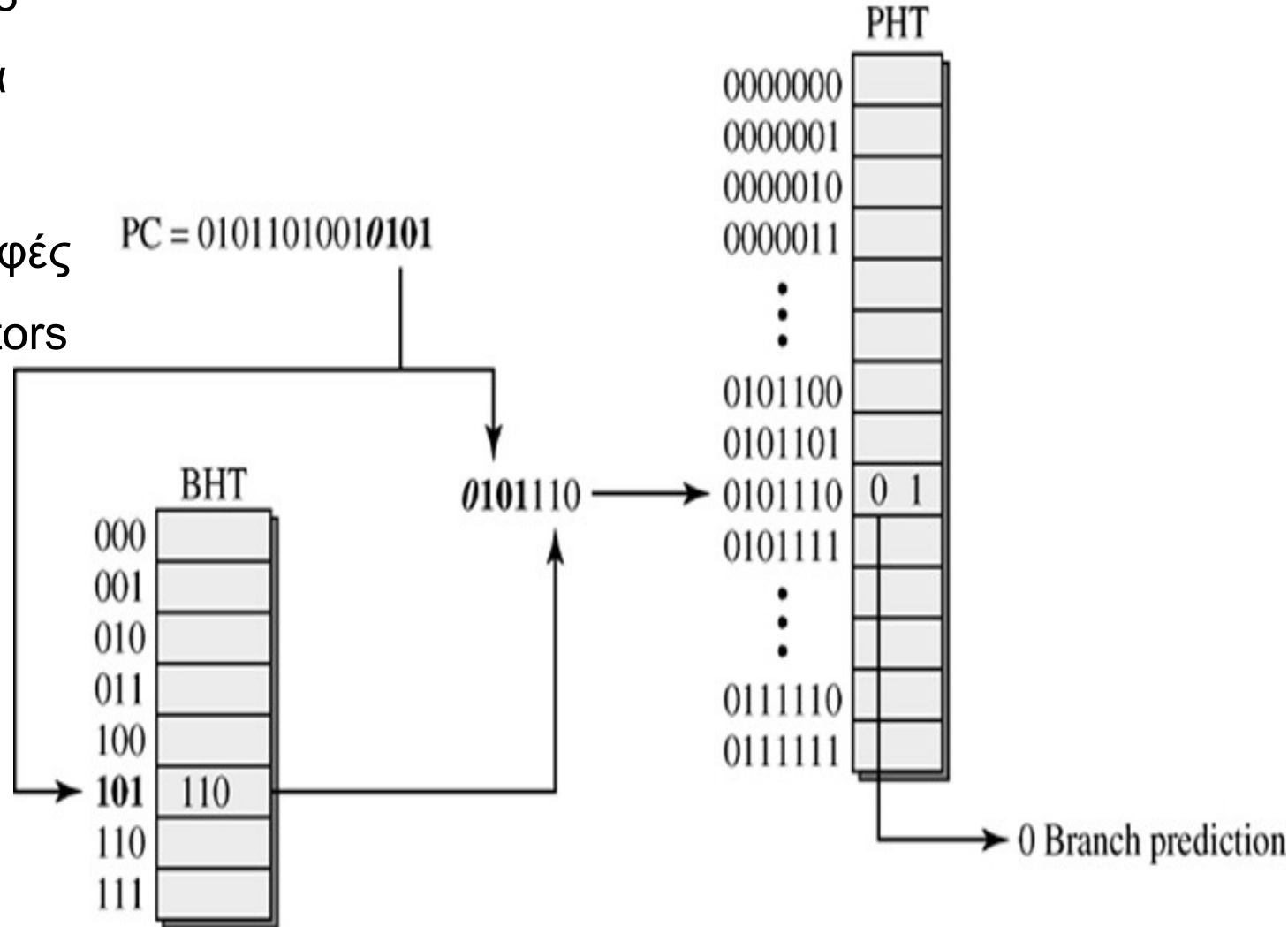

Άσκηση 4η (Total Prediction)

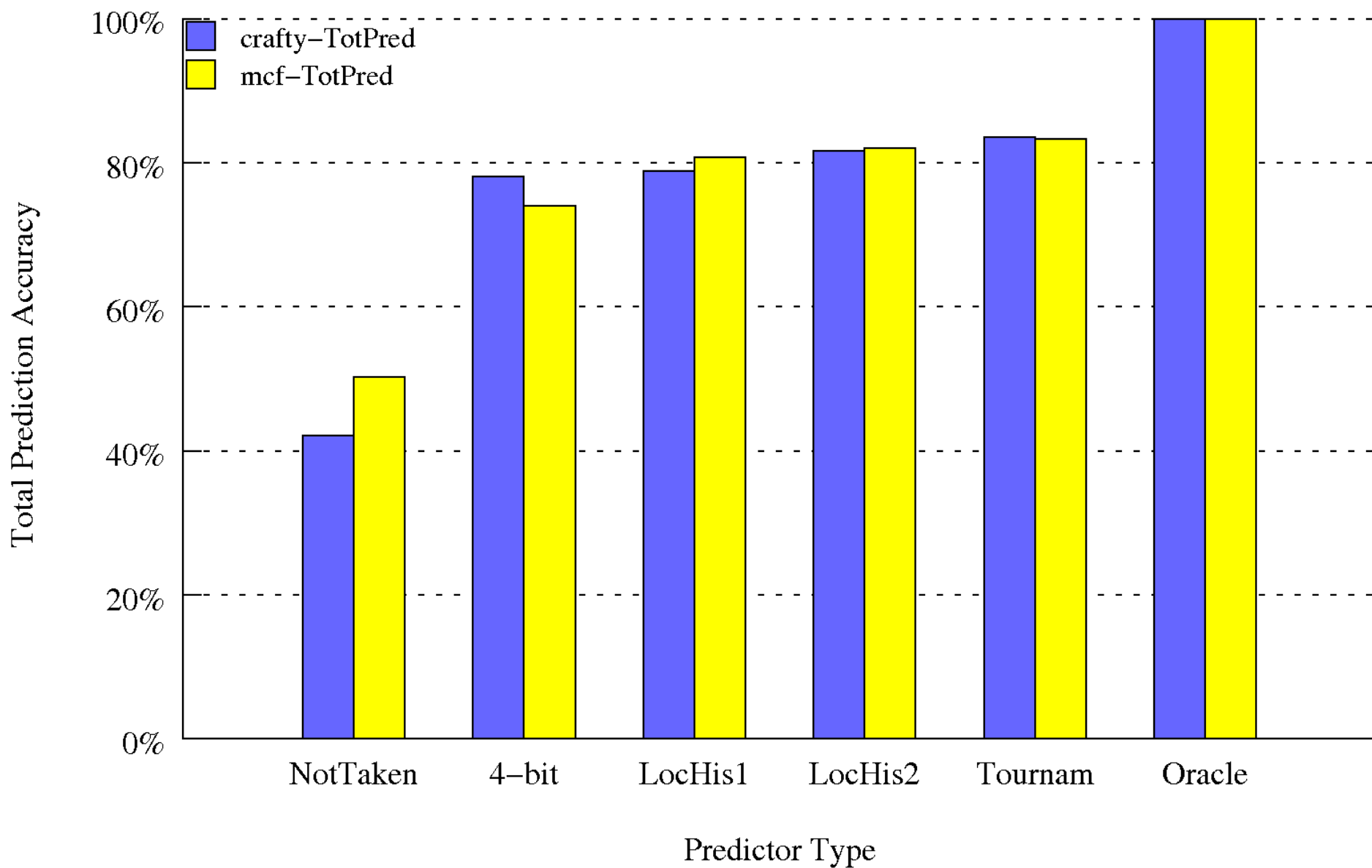

Άσκηση 4η (IPC)

